



## Closer\* Vascular Sealing System Instructions for Use

**CAUTION:** Federal (USA) law restricts this device to sale by or on the order of a physician

### DESCRIPTION

The Closer\* Vascular Sealing System (VSS) consists of the 1) Closer\* Delivery System and the 2) Closer\* Access Kit (Dilator and Insertion Sheath). The Closer\* VSS delivers a fully absorbable sealing mechanism to the femoral arterial puncture site. The sealing mechanism consists of an intravascular patch (the sealing member) and 2 extravascular spheres connected via 2 strands of sutures. After deployment, the patch will remain intravascular, and the 2 spheres will remain extravascular until absorbed. Hemostasis is achieved by mechanical means of the patch closing the arteriotomy from the inside of the puncture. The Closer\* VSS features a self-tightening mechanism that facilitates proper technique for delivery and deployment of the absorbable mechanism.

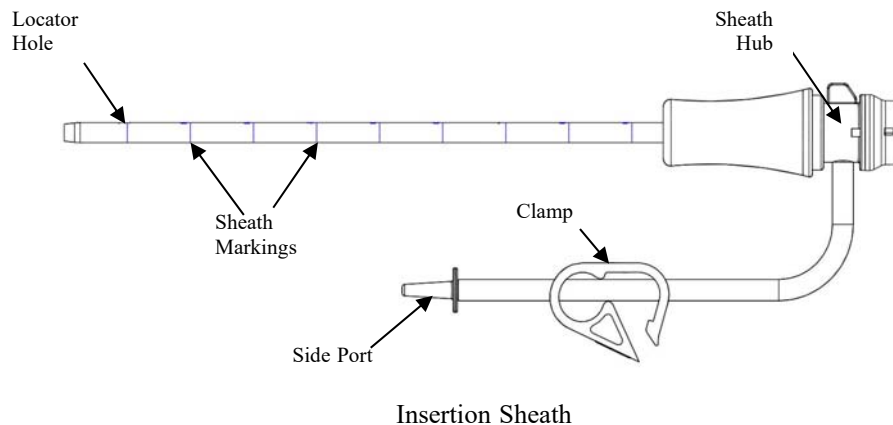
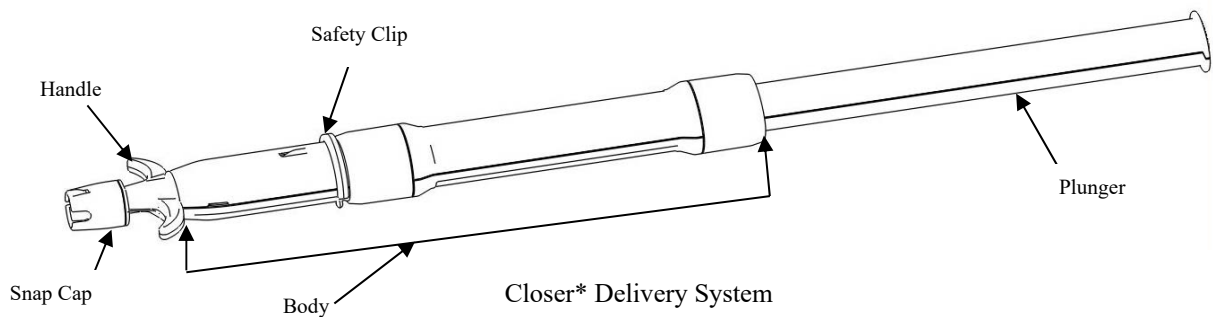

### INDICATION FOR USE

The Closer\* VSS is indicated for percutaneous closure of femoral arterial access sites while reducing times to hemostasis and ambulation in patients who have undergone diagnostic or interventional endovascular catheterization procedures utilizing 5, 6, or 7Fr introducer sheaths.

## CONTRAINDICATIONS

There are no known contraindications for this device.

## WARNINGS

- Do not use Closer\* VSS if the package/device is damaged, if any portion of the package has been previously opened, or if any item appears defective in any way.
- Do not use Closer\* VSS if the temperature indicator dot has changed from light grey to dark grey/black.
- Do not resterilize or re-use the Closer\* VSS in any manner; it is for SINGLE USE ONLY.
- Do not use Closer\* VSS if the posterior wall of the artery is punctured, or if the puncture site is a) proximal to the inguinal ligament, or b) at or distal to the bifurcation of the superficial femoral and profunda femoris artery, as this may result in 1) the intravascular sealing patch catching on the bifurcation or being positioned incorrectly, and/or 2) intravascular deployment of the device into the vessel (These 2 events may reduce blood flow through the vessel leading to symptoms of distal arterial insufficiency.) or 3) extravascular deployment of the device outside of the vessel (This event may result in retroperitoneal bleeding).
- Do not use Closer\* VSS if the sterile field has been broken or where bacterial contamination of the procedural sheath or surrounding tissues may have occurred as this may increase risk of infection.
- Do not use in patients with known allergies to polylactic acid (PLA), polyglycolic acid (PGA), or polydioxanone (PDO) polymers.

## PRECAUTIONS

- Do not use the Closer\* Delivery System with any sheath other than the insertion sheath provided in the kit. Use only the Closer\* Access Kit (insertion sheath/dilator combination) provided to locate the puncture in the arterial wall.
- The Closer\* VSS should be used within one hour of opening the foil pouch.
- If there is suspicion that the Closer\* Delivery System patch may not be seated against the intimal aspect of the arteriotomy site, the system components and delivery system should be simultaneously withdrawn from the patient. Hemostasis can then be achieved by applying manual pressure or other closure technique as directed by the physician.
- If femoral access is required within 90 days, it should be attempted on the contralateral side. If this is not possible, and re-puncture on the original treatment side is required, access the femoral artery at least 2 cm proximal to the original puncture site.
- Disposal of contaminated device, components, and packaging materials will be according to universal precautions for biohazardous waste.
- The Closer\* VSS should only be used by a trained licensed physician or healthcare professional.

Complications may occur and may be related to the endovascular procedure or the vascular closure. They include, but are not limited to:

- |                                   |   |                             |
|-----------------------------------|---|-----------------------------|
| ▪ Allergic response               | ▪ Edema   | ▪ Peripheral nerve injury   |
| ▪ Arterial occlusion              | ▪ Embolization (air, tissue, thrombus, calcific debris, device) | ▪ Pseudoaneurysm            |
| ▪ Arterial thrombus               | ▪ Hematoma  | ▪ Puncture site pain        |
| ▪ Arterio-venous fistula          | ▪ Infection   | ▪ Retroperitoneal bleeding  |
| ▪ Bleeding from the puncture site | ▪ Inflammatory response   | ▪ Venous thrombus formation |
| ▪ Bruising at the puncture site   | ▪ Intimal tear / dissection                                     | ▪ Vascular injury           |
| ▪ Death                           | ▪ Lower extremity ischemia                                      | ▪ Vasovagal response        |
| ▪ Device failure/malfunction      | ▪ Oozing from the puncture site                                 | ▪ Vasospasm                 |
|                                   | ▪ Perforation or laceration of the vessel wall                  | ▪ Wound dehiscence          |

## SPECIAL PATIENT POPULATIONS

The safety and effectiveness of Closer\* VSS have not been evaluated in the following patients who are/have:

- Less than 18 years of age;
- Pregnant and/or lactating women;
- Known significant history of bleeding diatheses or coagulopathy, a current platelet count  $< 100,000$  cells/mm<sup>3</sup>, or anemia (Hemoglobin  $< 10$  g/dl or Hematocrit  $< 30\%$ );
- Previous vascular surgery or repair in the vicinity of the target access site;
- Severe peripheral vascular disease in the ipsilateral limb requiring surgical or endovascular treatment within the previous or next 30 days;
- Severe nerve damage in the ipsilateral limb;
- Extreme morbid obesity (BMI  $> 45$  kg/m<sup>2</sup>);
- Fluoroscopically visible calcium or stent within 1 cm of puncture site;
- Systemic hypertension or hypotension (SBP  $< 90$  or  $> 180$  mmHg).
- Femoral artery  $< 5$  mm in diameter

## THE CLOSER\* VSS CLINICAL TRIAL

The Closer\* Clinical Study was a multi-center, prospective, nonrandomized single arm trial designed to evaluate the safety and effectiveness of the study device in sealing common femoral arterial access sites and providing reduced time to hemostasis (TTH) and time to ambulation (TTA), compared with pre-established TTH and TTA Performance Goals, at the completion of diagnostic or interventional endovascular procedures performed through introducer sheaths 5 to 7 Fr in size. For the evaluation of safety a Performance Goal and Clinical Acceptance Criteria for major complications and Clinical Acceptance Criteria for minor complications were pre-established. Subjects were all treated with the device at 11 sites in the United States. An ultrasound sub-study evaluated images of the access site from 50 consecutively enrolled, treated Closer\* VSS subjects at 3 sites at the time of the 30-day follow-up visit.

To be eligible for enrollment, patients were required to be between the ages of 18 and 80 years; able and willing to sign an Informed Consent Form; acceptable candidates for an elective, non-emergent diagnostic or interventional endovascular procedure via the common femoral artery using a 5, 6, or 7 Fr procedural sheath; and willing and able to complete a 30-day  $\pm$  7-day follow-up office visit. Subjects were excluded from enrollment if they had an immunodeficiency disorder; allergy to polylactic acid, polyglycolic acid, or polydioxanone polymers; bleeding disorder; planned endovascular or surgical procedure within the next 30 days; planned ipsilateral femoral arteriotomy within 90 days; arteriotomy in the ipsilateral groin within the past 30 days with residual complications; previous vessel closure device in the ipsilateral groin within the past 90 days; previous vascular surgery or repair near the access site; severe peripheral vascular disease in the ipsilateral limb requiring treatment within the previous or next 30 days; existing nerve damage in the ipsilateral limb; extreme morbid obesity (BMI > 45 kg/m<sup>2</sup>); administration of low molecular weight heparin within the previous 8 hours; femoral artery diameter < 5 mm; stenosis, anomalous branches, severe calcium, or stent near the puncture site; received unfractionated heparin with an ACT greater than 350 seconds in the absence of a glycoprotein (GP) IIb/IIIa inhibitor or greater than 250 seconds in the presence of a GP IIb/IIIa inhibitor; intra-proce dural bleeding around the sheath or suspected vessel complication; uncontrolled hypertension or hypotension; or planned extended hospitalization.

A total of 220 subjects, consisting of 111 diagnostic and 109 interventional patients, were enrolled. For the total patients, the mean age was 63.9 years and mean BMI was 30.3 kg/m<sup>2</sup>. Among the total patients, 68.2% were male and 31.8% were female. The study also included 42 roll-in patients, of whom 31 were diagnostic and 11 were interventional. Among the interventional patients, 65.1% received bivalirudin, 35.8% received unfractionated heparin, 66.1% received clopidogrel, and 0.9% GP IIb/IIIa inhibitor. Administration of at least 2 concomitant oral antiplatelet agents was reported in 51% of all subjects. The mean Activated Clotting Time (ACT) in subjects receiving unfractionated heparin was 211.6 seconds for diagnostic subjects and 249.1 seconds for interventional subjects.

Enrolled subjects were followed for 30  $\pm$  7 days. Of the 220 subjects, 219 (99.5%) subjects completed the 30-day follow-up. One interventional subject was lost to follow-up.

## SAFETY RESULTS

The primary safety endpoint was the 30-day incidence rate of combined access site closure-related major complications. There were zero (0) major access site closure-related complications reported in the study, as summarized in **Table 1**.

**Table 1: Access Site Closure-Related Major Complications by Procedure Type at 30 Days**

| Access Site Closure-Related Major Complications   | Diagnostic<br>(N=110) <sup>1</sup> |       | Interventional<br>(N=109) |       | Total<br>(N=219) |       |
|---|------------------------------------|-------|---------------------------|-------|------------------|-------|
|   |                                    |       |                           |       |                  |       |
| Any Major Access Site Closure-Related Complication  | 0                                  | 0.0%  | 0                         | 0.0%  | 0                | 0.0%  |
| Wilson-Score, 95% Confidence Interval <sup>2</sup>  | 0.00%                              | 3.37% | 0.00%                     | 3.40% | 0.00%            | 1.72% |
| Access site closure-related bleeding requiring transfusion  | 0                                  | 0.0%  | 0                         | 0.0%  | 0                | 0.0%  |
| Vascular injury requiring repair (via surgery, U/S guided compression, transcatheter embolization or stent graft)                 | 0                                  | 0.0%  | 0                         | 0.0%  | 0                | 0.0%  |
| New ipsilateral lower extremity ischemia causing a threat to viability of limb an requiring surgical or endovascular intervention | 0                                  | 0.0%  | 0                         | 0.0%  | 0                | 0.0%  |
| Access site closure-related infection requiring intravenous antibiotics and/or extended hospitalization                           | 0                                  | 0.0%  | 0                         | 0.0%  | 0                | 0.0%  |
| New onset access site closure-related neuropathy in the ipsilateral lower extremity requiring surgical repair                     | 0                                  | 0.0%  | 0                         | 0.0%  | 0                | 0.0%  |
| Permanent access site closure-related nerve injury (> 30 days)  | 0                                  | 0.0%  | 0                         | 0.0%  | 0                | 0.0%  |

<sup>1</sup> One diagnostic subject was lost to follow-up and so was omitted from the denominator.

<sup>2</sup> For the total subjects, the upper limit of the Wilson Score 95% Confidence Interval is well below the Performance Goal of 6%, indicating a strong rejection of the null hypothesis that the Closer\* VSS's major access site closure-related complication rate is greater than the Performance Goal of 6% (p<0.0001). The clinical acceptance criterion rate for diagnostic subjects was 2.1% and the clinical acceptance criterion rate for interventional subjects was 2.1%.

The secondary safety endpoint was the 30-day incidence rate of combined access site closure-related minor complications. The only reported minor complications were access site closure-related bleeding requiring > 30 minutes to achieve initial arterial hemostasis which was reported in 3 subjects, 2 of which did not have the patch deployed according to the IFU. These events are summarized in Table 2.

**Table 2: 30-Day Incidence of Access Site Closure-Related Minor Complications by Procedure Type at 30 Days**

| Access Site Closure-Related Minor Complications   | Diagnostic <sup>1</sup> |      | Interventional <sup>2</sup> |       | Total <sup>3</sup> |       |
|---|-------------------------|------|-----------------------------|-------|--------------------|-------|
|   | (N=110)                 |      | (N=109)                     |       | (N=219)            |       |
| Any Access Site Closure-Related Minor Complication  | 0                       | 0.0% | 3                           | 2.75% | 3                  | 1.37% |
| Access site closure-related bleeding requiring >30 min. of continual manual compression to achieve initial arterial hemostasis  | 0                       | 0.0% | 3                           | 2.75% | 3                  | 1.37% |
| Late access site closure-related arterial bleeding (following hospital discharge)   | 0                       | 0.0% | 0                           | 0.0%  | 0                  | 0.0%  |
| Access site closure-related hematoma ≥ 6 cm   | 0                       | 0.0% | 0                           | 0.0%  | 0                  | 0.0%  |
| Ipsilateral lower extremity arterial emboli   | 0                       | 0.0% | 0                           | 0.0%  | 0                  | 0.0%  |
| Ipsilateral deep vein thrombosis  | 0                       | 0.0% | 0                           | 0.0%  | 0                  | 0.0%  |
| Access site closure-related vessel laceration   | 0                       | 0.0% | 0                           | 0.0%  | 0                  | 0.0%  |
| Access site wound dehiscence  | 0                       | 0.0% | 0                           | 0.0%  | 0                  | 0.0%  |
| Localized access site infection treated with intramuscular or oral antibiotics  | 0                       | 0.0% | 0                           | 0.0%  | 0                  | 0.0%  |
| Arteriovenous fistula not requiring treatment   | 0                       | 0.0% | 0                           | 0.0%  | 0                  | 0.0%  |
| Pseudoaneurysm requiring thrombin injection or fibrin adhesive injection  | 0                       | 0.0% | 0                           | 0.0%  | 0                  | 0.0%  |
| Pseudoaneurysm not requiring treatment  | 0                       | 0.0% | 0                           | 0.0%  | 0                  | 0.0%  |
| New onset of transient access site closure-related neuropathy in the ipsilateral lower extremity that is transient (≥ 24 hrs. and ≤ 30 days) and does not require surgical repair | 0                       | 0.0% | 0                           | 0.0%  | 0                  | 0.0%  |

<sup>1</sup> Diagnostic subject 10-203 was lost to follow-up and so was omitted from the denominator.

<sup>2</sup> Includes 1 case of known user error and 1 case of suspected user error, both resulting in failure to deploy the patch and subsequent prolonged hemostasis times. Excluding these 2 instances/subjects, the overall access site closure-related minor event rate is 0/110 (0.0%) diagnostic, 1/109 (0.9%) interventional, and 1/219 (0.5%) total.

<sup>3</sup> Observed event rates are well below the predetermined clinical acceptance criteria rates of 5.2% for diagnostic subjects and 6.2% for interventional subjects.

In the 30-day ultrasound sub-study an intraluminal defect adherent to the anterior wall of the common femoral artery wall was noted in 12 patients which was felt to be the Closer device as it continued to degrade and considered by the Data Safety Monitoring Committee to be of no clinical significance. All vessels were noted to be patent or < 50% stenosed. In 2 of these patients the ultrasound exams also showed what the ultrasound core laboratory considered to be an arterial thrombus in the same location. These thrombi were subclinical although one of them was prophylactically treated with warfarin and not seen on a repeat femoral ultrasound done 1 month later and the other was not detected by the site.

**EFFECTIVENESS RESULTS**

Tables 3a, 3b, 3c, and 3d summarize the primary effectiveness endpoint of Time to Hemostasis (TTH), the key secondary effectiveness endpoint of Time to Ambulation (TTA), and the additional secondary effectiveness endpoints of Time to Discharge Eligibility (TTDE) and Time to Discharge (TTD).

**Table 3a: Primary Effectiveness Endpoint TTH Results**

| Time to Hemostasis (minutes) <sup>1</sup> | Diagnostic (n = 111)     | Interventional (n = 109)    | Total (n = 220)             |
|---|--------------------------|-----------------------------|-----------------------------|
| Mean ± Standard Dev (95% C.I.)            | 0.58 ± 2.94 (0.03, 1.13) | 3.01 ± 10.58 (1.00, 5.01)   | 1.78 ± 7.81 (0.74, 2.82)    |
| Median (95% C.I.)                         | 0.00 (0.00, 0.00)        | 0.00 (0.00, 0.00)           | 0.00 (0.00, 0.00)           |
| Range (Min, Max)                          | (0.00, 28.32)            | (0.00, 85.28 <sup>2</sup> ) | (0.00, 85.28 <sup>2</sup> ) |
| Performance Goal (p-value <sup>3</sup> )  | 17 (< 0.001)             | 24 (< 0.001)                | N/A (< 0.001)               |

<sup>1</sup> TTH for Closer\* VSS was statistically significantly less than predetermined Performance Goals (PGs) in all three cases (diagnostic PG 17 min., interventional PG 24 min., and combined) by both t-test and Wilcoxon’s signed rank test (p<0.0001).

<sup>2</sup> One interventional subject did not have the patch deployed due to user error, resulting in an outlier TTH of 85.28 minutes.

<sup>3</sup> By both two-sided t-test and Wilcoxon’s signed rank test.

**Table 3b: Secondary Effectiveness Endpoint TTA Results**

| Time to Ambulation (hours) <sup>1</sup>  | Diagnostic (n = 111)     | Interventional (n = 109) | Total (n = 220)          |
|--|--------------------------|--------------------------|--------------------------|
| Mean ± Standard Dev (95% C.I.)           | 1.92 ± 0.67 (1.80, 2.05) | 3.09 ± 1.05 (2.89, 3.29) | 2.50 ± 1.05 (2.36, 2.64) |
| Median (95% C.I.)                        | 1.95 (1.80, 2.29)        | 2.90 (2.80, 3.01)        | 2.24 (2.14, 2.49)        |
| Range (Min, Max)                         | (1.01, 6.02)             | (1.99, 8.08)             | (1.01, 8.08)             |
| Performance Goal (p-value <sup>3</sup> ) | 6 (< 0.001)              | 11 (< 0.001)             | N/A (< 0.001)            |

<sup>1</sup> TTA for Closer\* VSS was statistically significantly less than predetermined PGs in all three cases (diagnostic PG 6 hrs., interventional PG 11 hrs., and combined) by both t-test and Wilcoxon’s signed rank test (p <0.0001).

**Table 3c: Secondary Effectiveness Endpoint TTDE Results**

| Time to Discharge Eligibility (hours) | Diagnostic (n = 111)     | Interventional (n = 109) | Total (n = 220)          |
|---------------------------------------|--------------------------|--------------------------|--------------------------|
| Mean ± Standard Dev (95% C.I.)        | 2.17 ± 0.67 (2.04, 2.29) | 3.50 ± 1.86 (3.15, 3.85) | 2.83 ± 1.54 (2.62, 3.03) |
| Median (95% C.I.)                     | 2.16 (1.97, 2.25)        | 3.19 (3.01, 3.29)        | 2.51 (2.42, 2.75)        |
| Range (Min, Max)                      | (1.22, 6.05)             | (2.24, 19.32)            | (1.22, 19.32)            |

**Table 3d: Secondary Effectiveness Endpoint TTD Results**

| Time to Discharge (hours)      | Diagnostic (n = 111)     | Interventional (n = 109)     | Total (n = 220)              |
|--------------------------------|--------------------------|------------------------------|------------------------------|
| Mean ± Standard Dev (95% C.I.) | 4.57 ± 6.35 (3.38, 5.77) | 21.83 ± 18.93 (18.24, 25.43) | 13.12 ± 16.49 (10.93, 15.32) |
| Median (95% C.I.)              | 2.97 (2.65, 3.36)        | 22.66 (20.86, 23.59)         | 4.74 (4.04, 6.64)            |
| Range (Min, Max)               | (1.44, 53.01)            | (2.29, 122.01)               | (1.44, 122.01)               |

**Table 4** summarizes the secondary effectiveness endpoints of Procedure Success, defined as attainment of final hemostasis using any method and freedom from major access site closure-related complications through 30 days. The Procedure Success Rate was 100% for all subjects.

**Table 4: Secondary Effectiveness, Procedure Success**

| Procedure      | Number of Subjects <sup>1</sup> | Number of Successes | Success Rate | 95% Confidence Interval <sup>2</sup> |        |
|----------------|---------------------------------|---------------------|--------------|--------------------------------------|--------|
|                |                                 |                     |              |                                      |        |
| Diagnostic     | 110                             | 110                 | 100%         | 96.6%                                | 100.0% |
| Interventional | 109                             | 109                 | 100%         | 96.6%                                | 100.0% |
| Total          | 219                             | 219                 | 100%         | 98.3%                                | 100.0% |

<sup>1</sup> Diagnostic subject 10-203 was lost to follow-up and so was omitted from the denominator for Procedure Success tabulation.

<sup>2</sup> 95% Exact Binomial Confidence Interval

**Table 5** summarizes the secondary effectiveness endpoint of Device Success, defined as the ability to deploy the delivery system, deliver the implant, and achieve hemostasis with the Closer\* VSS alone or with adjunctive compression. For the total subjects Device Success was achieved in 98.2% of the cases in which device deployment was attempted.

**Table 5: Secondary Effectiveness, Device Success**

| Procedure      | Number of Subjects <sup>1</sup> | Number of Successes | Success Rate | 95% Confidence Interval <sup>2</sup> |       |
|----------------|---------------------------------|---------------------|--------------|--------------------------------------|-------|
|                |                                 |                     |              |                                      |       |
| Diagnostic     | 111                             | 110                 | 99.1%        | 95.1%                                | 99.8% |
| Interventional | 109                             | 106                 | 97.2%        | 92.2%                                | 99.1% |
| Total          | 220                             | 216                 | 98.2%        | 95.4%                                | 99.3% |

<sup>1</sup> Includes 3 instances of known user error and subsequent failure to follow written Instructions for Use, resulting in non-deployment of the patch. Excluding these 3 instances, Device Success rates are 110/110 (100%) for the diagnostic group, 106/107 (99.1%) for the interventional group, and 216/217 (99.5%) for all subjects.

<sup>2</sup> 95% Exact Binomial Confidence Interval

**Tables 6, 7, 8, and 9** summarize the cumulative data for TTH, TTA, TTDE, and TTD, respectively. Over 80% of subjects had TTH = 0 seconds; over 77% of subjects ambulated in ≤ 3 hours, and over 92% of subjects were eligible for hospital discharge at ≤ 4 hours, based on the access site assessment only.

**Table 6: Cumulative Time to Hemostasis (TTH), by Procedure Type**

| Time to hemostasis        | Diagnostic<br>(n = 111) |        | Interventional<br>(n = 109) |        | Total<br>(n = 220) |        |
|---------------------------|-------------------------|--------|-----------------------------|--------|--------------------|--------|
|                           |                         |        |                             |        |                    |        |
| 0 minutes                 | 97                      | 87.4%  | 80                          | 73.4%  | 177                | 80.5%  |
| ≤ 1 minute                | 103                     | 92.8%  | 89                          | 81.7%  | 192                | 87.3%  |
| ≤ 5 minutes               | 107                     | 96.4%  | 96                          | 88.1%  | 203                | 92.3%  |
| ≤ 10 minutes              | 110                     | 99.1%  | 99                          | 90.8%  | 209                | 95.0%  |
| ≤ 15 minutes              | 110                     | 99.1%  | 103                         | 94.5%  | 213                | 96.8%  |
| ≤ 30 minutes              | 111                     | 100.0% | 106                         | 97.2%  | 217                | 98.6%  |
| ≤ 60 minutes              | 111                     | 100.0% | 108                         | 99.1%  | 219                | 99.6%  |
| ≤ 90 minutes <sup>1</sup> | 111                     | 100.0% | 109                         | 100.0% | 220                | 100.0% |

<sup>1</sup> One interventional subject did not have the patch deployed due to user error, resulting in an outlier TTH of 85 minutes.

**Table 7: Cumulative Time to Ambulation (TTA), by Procedure Type**

| Time to Ambulation | Diagnostic<br>(n = 111) |        | Interventional<br>(n = 109) |        | Total<br>(n = 220) |        |
|--------------------|-------------------------|--------|-----------------------------|--------|--------------------|--------|
|                    |                         |        |                             |        |                    |        |
| ≤ 1 hour           | 0                       | 0.0%   | 0                           | 0.0%   | 0                  | 0.0%   |
| ≤ 2 hours          | 69                      | 62.2%  | 2                           | 1.8%   | 71                 | 32.3%  |
| ≤ 3 hours          | 105                     | 94.6%  | 65                          | 59.6%  | 170                | 77.3%  |
| ≤ 4 hours          | 109                     | 98.2%  | 97                          | 89.0%  | 206                | 93.6%  |
| ≤ 5 hours          | 110                     | 99.1%  | 102                         | 93.6%  | 212                | 96.4%  |
| ≤ 7 hours          | 111                     | 100.0% | 107                         | 98.2%  | 218                | 99.1%  |
| ≤ 9 hours          | 111                     | 100.0% | 109                         | 100.0% | 220                | 100.0% |

**Table 8: Cumulative Time to Discharge Eligibility (TTDE), by Procedure Type**

| Time to Discharge Eligibility | Diagnostic<br>(n = 111) |        | Interventional<br>(n = 109) |        | Total<br>(n = 220) |        |
|-------------------------------|-------------------------|--------|-----------------------------|--------|--------------------|--------|
| ≤ 2 hours                     | 47                      | 42.3%  | 0                           | 0.0%   | 47                 | 21.4%  |
| ≤ 4 hours                     | 109                     | 98.2%  | 95                          | 87.2%  | 204                | 92.7%  |
| ≤ 6 hours                     | 110                     | 99.1%  | 103                         | 94.5%  | 213                | 96.8%  |
| ≤ 8 hours                     | 111                     | 100.0% | 107                         | 98.2%  | 218                | 99.1%  |
| ≤ 12 hours                    | 111                     | 100.0% | 108                         | 99.1%  | 219                | 99.6%  |
| ≤ 24 hours                    | 111                     | 100.0% | 109                         | 100.0% | 220                | 100.0% |

**Table 9: Cumulative Time to Hospital Discharge (TTD), by Procedure Type**

| Time to Discharge Eligibility | Diagnostic<br>(n = 111) |       | Interventional<br>(n = 109) |       | Total<br>(n = 220) |       |
|-------------------------------|-------------------------|-------|-----------------------------|-------|--------------------|-------|
| ≤ 2 hours                     | 15                      | 13.5% | 0                           | 0.0%  | 15                 | 6.8%  |
| ≤ 4 hours                     | 84                      | 75.7% | 10                          | 9.2%  | 94                 | 42.7% |
| ≤ 6 hours                     | 99                      | 89.2% | 21                          | 19.3% | 120                | 54.6% |
| ≤ 8 hours                     | 102                     | 91.9% | 28                          | 25.7% | 130                | 59.1% |
| ≤ 12 hours                    | 105                     | 94.6% | 29                          | 26.6% | 134                | 60.9% |
| ≤ 24 hours                    | 109                     | 98.2% | 73                          | 67.0% | 182                | 82.7% |
| ≤ 48 hours                    | 110                     | 99.1% | 105                         | 96.3% | 215                | 97.7% |

**CONCLUSIONS**

The results from the Closer\* Clinical Study demonstrate that patients who have undergone cardiac or peripheral diagnostic or interventional procedures using a 5, 6, or 7 Fr procedural sheath and were treated with Closer\* VSS have reduced times to hemostasis and ambulation when compared to pre-established Performance Goals. The study data provide scientifically valid evidence that the device is safe and effective when used in accordance with the device labeling.

**CLOSER\* VSS INSERTION PROCEDURE**

The medical techniques and procedures described in these Instructions for Use do not represent ALL medically acceptable protocols, nor are they intended as a substitute for the clinician’s experience and judgment in treating any specific patient. Prior to use, inspect the packages for damage (such as punctures, tears, or open seals), verify that the expiration date has not passed, and verify that the temperature sensor dot is light gray in color.

The Closer\* VSS procedure is composed of three steps:

- A. Locate the Artery, using the Closer\* Access Kit
- B. Set the Patch
- C. Seal the Puncture

**A. Locate the Artery**

1. Assess the puncture site location and evaluate the femoral artery characteristics prior to placing the Closer\* VSS by injecting contrast medium through the procedure sheath followed by an angiogram.  
**WARNING: Do not use Closer\* VSS if the posterior wall of the artery is punctured, or if the puncture site is a) proximal to the inguinal ligament, or b) at or distal to the bifurcation of the superficial femoral and profunda femoris artery, as this may result in 1) the intravascular sealing patch catching on the bifurcation or being positioned incorrectly, and/or 2) intravascular deployment of the device into the vessel. (These 2 events may reduce blood flow through the vessel leading to symptoms of distal arterial insufficiency.)**
2. Using sterile technique, remove the Closer\* VSS and Access Kit (Insertion Sheath & Dilator) contents from their respective sterile packages.
3. Insert the Dilator into the Insertion Sheath; verify the two pieces snap together securely and that the clamp is open.
4. Insert a 0.035” (0.89mm) or 0.038” (0.96mm) guidewire into the procedural sheath that is currently in the vessel. It is advisable to verify that the skin incision is of sufficient size to accommodate the Closer\* Insertion Sheath.
5. Remove the procedural sheath, leaving the guidewire in place to maintain vascular access.
6. Thread the Closer\* Access Kit over the guidewire; the side port of the Insertion Sheath must be aligned with and pointed towards the femoral artery.  
**CAUTION: Sheath orientation must be maintained to ensure that the device is delivered within the arterial wall as designed.**
7. Advance the Closer\* Access Kit into the arteriotomy until blood begins to flow out from the side port (Figure A.7).  
**NOTE: Ensure that the clamp is in the open position while advancing the Insertion Sheath to enable blood flow.**

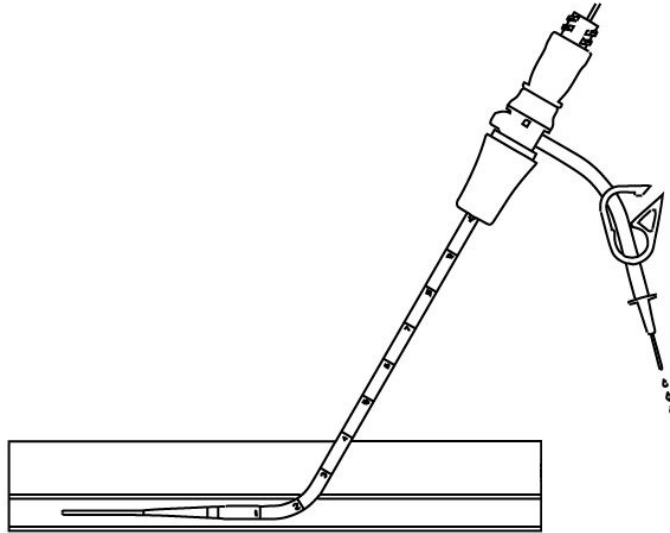

Figure A.7

8. Slowly withdraw the Closer\* Access Kit until blood slows or stops flowing from the side port (Figure A.8). This indicates that the locator hole of the Closer\* Access Kit has just exited the artery.

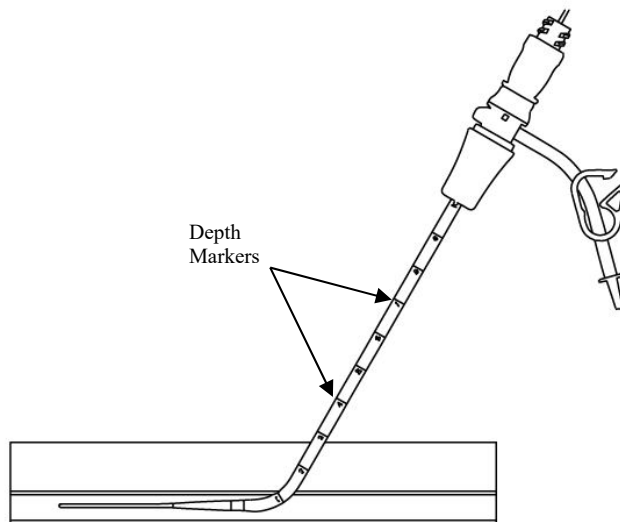

Figure A.8

9. Re-advance the Closer\* Access Kit until blood begins to flow from the side port again. If blood flow does not resume, repeat Steps A-7 and A-8 until blood flows from the side port again upon advancement of the Access Kit into the artery.
10. Once blood flow from the side port is re-established, advance the Access Kit an additional 1cm into the artery using the depth markers on the Insertion Sheath as a guide (Figure A.8).  
**CAUTION: Over-insertion of the Access Kit beyond 1 cm into the artery may result in intravascular deployment and possible embolization of the patch. Failure to insert the Access Kit at least 1 cm into the artery may result in extravascular deployment into the tissue tract, which may require conversion to manual compression to achieve hemostasis.**
11. Identify the Access Kit depth, based on the depth markers (Figure A.8) on the Insertion Sheath. This depth must be maintained throughout the deployment of the Closer\* VSS.  
**CAUTION: Failure to maintain proper depth of the Access Kit in the artery may result in intravascular deployment and possible embolization of the patch if the Access Kit is too deep, or may result in extravascular deployment into the tissue tract and conversion to manual compression to achieve arterial hemostasis if the Access Kit is too shallow.**
12. Close side port clamp to stop the flow of blood.
13. Maintaining Insertion Sheath depth, carefully remove the Dilator and guidewire from the Insertion Sheath while maintaining a 45 to 60 degree angle (Figure A.13).



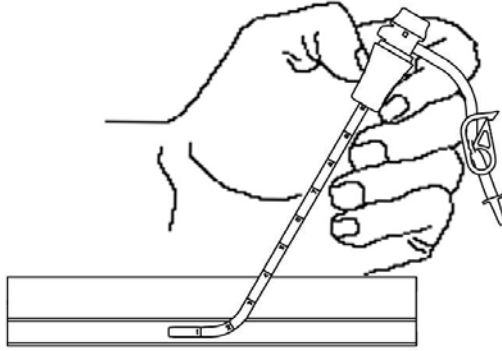

Figure A.13

**CAUTION: Sheath orientation and depth must be maintained for proper deployment. Using the Insertion Sheath depth markers as a guide, ensure that the sheath position has not changed. If re-advancement is necessary, the guidewire and dilator must be reinserted prior to advancing the Insertion Sheath.**

#### B. Set the Patch

1. Remove the red safety clip from the Closer\* VSS.
2. Orient the snap cap of the Closer\* VSS to the Insertion Sheath hub such that the snap cap is aligned to accept the side port tubing of the Insertion Sheath (Figure B.2).

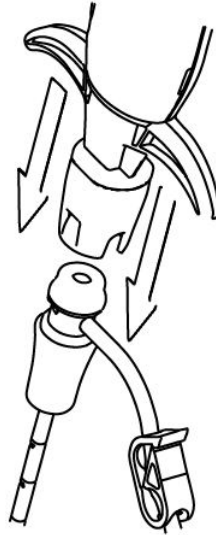

Figure B.2

3. While maintaining Insertion Sheath depth, attach the snap cap to the Insertion Sheath hub until an audible “click” is heard. Ensure the Closer\* VSS is securely attached to the Insertion Sheath.  
**CAUTION: Support the sheath from this point forward to prevent it from kinking (as shown in Figure A.13). Kinking of the sheath may cause the device to be unable to plunge, resulting in loss of access.**
4. While supporting the delivery system body and maintaining Insertion Sheath depth, ensure that the access angle is maintained at 45 to 60 degrees. Fully advance the plunger forward until an audible “click” is heard indicating the sealing mechanism has advanced through the Insertion Sheath and into the artery (Figure B.4).

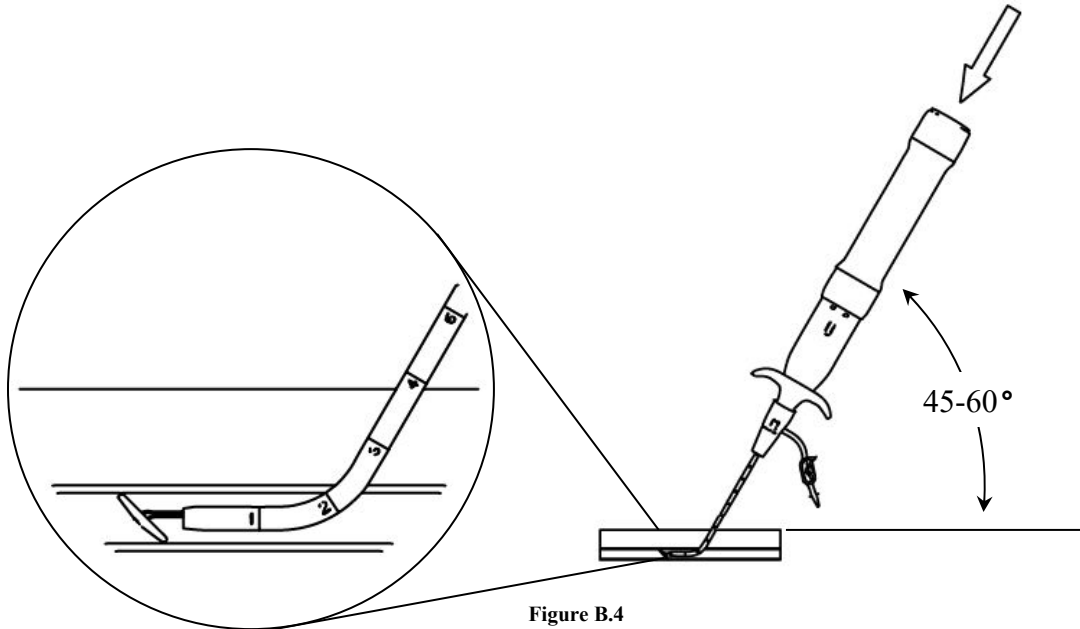

Figure B.4

**CAUTION: Maintaining sheath orientation and depth is critical to procedural success. If necessary, rotate the Insertion Sheath so that the side port of the Sheath is pointed towards the femoral artery. Failure to maintain sheath angle may result in loss of access.**

5. Support the puncture site with two fingers, one on each side of the sheath.
6. Gently retract the Closer\* VSS starting at approximately 45°- 60° angle with respect to the artery and smoothly transition to a 90° angle (Figure C.2) as the patch seats against vessel wall (until resistance is felt). Pause with light tension, dab puncture site, and assess for temporary hemostasis.

**CAUTION: If temporary hemostasis is not achieved, proceed to Step C and apply manual compression at the end of the procedure.**

#### C. Seal the Puncture

1. Apply continuous and firm counter-pressure at the puncture site with two fingers, one on each side of the sheath during the entire withdrawal procedure (Figure C.2).

**CAUTION: Allowing the access site tissue to “tent” during withdrawal of the device may result in inadequate cinching of the sutures to close the arteriotomy.**

2. While maintaining approximately 90° angle, continuously and carefully withdraw the delivery system by the handle (Figure C.2).

**NOTE: Four resistance points will be felt during the Closer\* VSS deployment. At this point, the device has been deployed and sutures will extend outside the tract.**

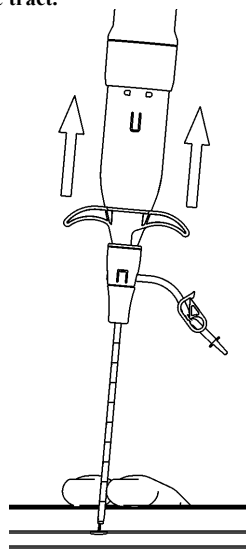

Figure C.2

3. Continue to pull on the Closer\* VSS until the suture is completely released from the delivery system.  
**NOTE: If the sutures are not released from the delivery system or the device begins to pull with excessive force (above 5 lbs) the suture should be cut free of the device.**  
**CAUTION: Do not tug on sutures after deployment, due to risk of vascular damage and patch malpositioning.**
4. Assess the patient for hemostasis; if blood continues to seep after the Closer\* VSS is deployed, briefly apply light digital pressure (2 fingers) at the puncture site, and then reassess. If manual pressure is necessary, monitor pedal pulses.
5. While maintaining slight tension on the suture, use a sterile instrument to cut the suture below the skin level.
6. Clean the puncture site with an antiseptic solution/ointment.
7. Apply a sterile dressing to the puncture site so that it can be easily observed during recovery.
8. Maintain bedrest as prescribed by the physician, and periodically check the access site until ambulation.

Complete the Patient Card and provide to the patient.

The Closer Vascular Sealing System is MR Safe.

**Disclaimer of Warranty and Limitation of Remedy**

There is no express or implied warranty, including without limitation any implied warranty of merchantability or fitness for a particular purpose, on the Manufacturer or its Distributors product(s) described in this publication. Under no circumstances shall the Manufacturer or its Distributor be liable for any direct, incidental or consequential damages other than as expressly provided by specific law. No person has the authority to bind the Manufacturer or its Distributor to any representation or warranty except as specifically set forth herein.



















Descriptions or specifications in the manufacturer and distributor's printed matter, including this publication, are meant solely to generally describe the product at the time of manufacture and do not constitute any express warranties.

Manufacturer and Distributor will not be responsible for any direct, incidental or consequential damages resulting from reuse of the product.

\* Trademark of Rex Medical, L.P.

Manufactured under one or more of the following U.S. patents: 8,070,772; 8,491,629; 8,597,324; 8,968,361; 9,226,738; 9,295,458; 9,339,261; 9,463,005

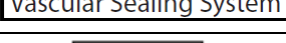
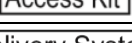
## Graphical Symbols for Medical Device Labeling

|   |  |
|---|--|
|    | See Instructions For Use   |
|    | Keep Away from Sunlight  |
|    | Do Not Use if Temperature Indicator Dot on Package has turned from Light Grey to Dark Grey or Black. |
|    | Quantity   |
|    | Do not Reuse – Single Use Only   |
|    | Use By Date  |
|    | Lot Number   |
|    | Sterilized using Irradiation   |
|    | Sterilized using Ethylene Oxide  |
|    | Do Not Re-sterilize  |
|    | Read Instructions for Use  |
|   | Keep Dry – Protect from Moisture   |
|  | Do Not Use if Package is Open or Damaged   |
|  | Maximum and Minimum Temperature, 15° C - 25° C   |
|  | Model Number   |
|  | Manufacturer   |
|  | Vascular Sealing System  |
|  | Access Kit   |
|  | Delivery System  |
|  | Federal (USA) law restricts this device to sale by, or on the order of, a physician                  |

  
 Conshohocken, PA-19428  
[www.rexmedical.com](http://www.rexmedical.com)

P: (610) 940-0665 • F: (610) 940-1590